



AQUASTAR[®] *control*

USER MANUAL

EN

AQUASTAR[®] *control*

User Manual



CONTENTS

1	Copyrights	6
2	Introduction to Operation Manual	6
3	Warranty and Liability	7
4	Instructions for Safety at Work	7
5	Safety Instructions	8
6	Residual Risk	9
6.1	Hazard Generated by Current	9
6.2	Hazard Generated by Human Error	9
6.3	Hazard Generated by Current during Cleaning Work	9
7	General	9
8	Directions for Use	9
9	Assembly	10
9.1	Function Diagram for Praher Plastics Austria V6 Valves	10
10	Electric Connection	11
10.1	Connections on the Front of the Circuit Board	11
10.2	Connections on the Back of the Circuit Board	13
10.3	Connections at the Center of the Circuit Board	14
11	Battery	15
11.1	How to Change the Battery:	15
11.2	Disposal Considerations:	15
12	Display and Buttons	16
13	Splash Screen	17
13.1	Standard	17
13.2	Heating Control	17
13.3	Error/Information	17
14	Main Menu	18
14.1	Backwash	18
14.2	Filter Pump	18
14.3	Positioning	20
14.4	Statistics	23

14.5 Notifications	23
14.6 Information	24
14.7 Settings	24
15 Circuit Boards	33
15.1 Main Board	33
15.2 Power Supply Board	33
16 Explosion Drawing of Aquastar Control	34
17 Technical Data	35
18 Emergency Handle	35
19 Fitting and Dismantling Aquastar Control	36
19.1 Dismantling the Aquastar Control	36
19.2 Fitting the Aquastar Control	37
20 Aquastar Control Accessories	38
21 Troubleshooting	39
21.1 Troubleshooting Software	39
21.2 Troubleshooting Hardware	41

as defined by EC-directive(s)

- Electromagnetic Compatibility 2014/30/EU
- Low Voltage 2014/35/EU
- Machinery directive 2006/42/EG

PRODUCT control unit for a Praher Plastics Austria multiport valve
 fabricate Aquastar
 type Control

is developed, designed and produced in accordance with above mentioned EC-directive(s), under the own responsibility of

Company PRAHER Plastics Austria GmbH, Poneggenstr. 5, 4311 Schwertberg, AUSTRIA
 Conformity procedures Module A

Applied harmonized standards, guidelines and specifications in particular:

- EN 60730-1:2017, Automatic electrical controls for household and similar use
- EN 55022, Class B, Limits for household and business application
- EN 60335-1:2012, Safety of electric devices for household and business application
- EN 61000-6-3:2011, Emission standard for residential, commercial and light-industrial environments
- EN 61000-6-1:2019, Emission standard for residential, commercial and light-industrial environments
- EN 61000-6-2:2019, Emission standard for industrial environments
- ETG 1992, BGBl. Nr. 106/1993
- NspGV 2015, BGBl. II Nr. 21/2016
- EMVV 2015, BGBl. II Nr. 22/2016
- _____

A complete technical documentation is existing.
 The associated operating instruction of the product is given.

Schwertberg, 14.09.2021

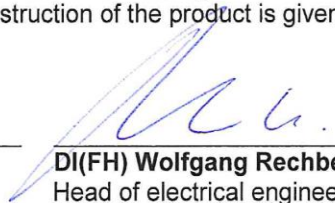
DI(FH) Wolfgang Rechberger
 Head of electrical engineering

Dr. Rainer Pühringer
 CEO

158-FEET23022015 KE ASC

1 Copyrights

This operation manual contains copyright protected information.

All rights reserved to Praher Plastics Austria GmbH.

This operation manual is designed for use by operating personnel only. Copying, reproduction or translation of the present document into other languages in whole or in part is subject to express written permission by Praher Plastics Austria GmbH.

© 2021 Praher Plastics Austria GmbH

These operating instructions have been written with the intention of being read, understood and observed in all points by those who are responsible for the Aquastar Control area. Knowledge of the instructions contained in this operation manual is indispensable for preventing failure and ensuring faultless operation of the Aquastar Control. Therefore, it is essential that the person in charge of operating the equipment is familiar with the present documentation.

2 Introduction to Operation Manual

This operation manual is intended to facilitate familiarization with the Aquastar Control and utilization of the same for the intended purpose.

This operation manual contains important information for safe, proper and economical operation of the Aquastar Control. Compliance with these instructions will contribute to

- preventing danger
- reducing repair costs and equipment failure, and
- increasing the liability and service life of the Aquastar Control

This operation manual supplements the instructions provided by existing accident prevention and environmental protection regulations. It must be available at the place of utilization of the equipment at any time and must be read by each person intending to use the Aquastar Control. This means

- operation, including
- correction measures in case of faulty operation and
- maintenance

In addition to the operation manual and the compulsory accident prevention regulations applicable at the place of utilization of the equipment, the generally subject specific technical rules must be taken into account.

3 Warranty and Liability

Warranty and liability claims in the context of damage to person or property shall be excluded where such damage results from one or several of the causes listed below:

- Improper use of the Aquastar Control
- Improper installation, putting into operation, operation and maintenance of the Aquastar Control
- Operation of the Aquastar Control with defective or improper safety devices
- Non-compliance with the instructions contained in the operation manual for installation, putting into operation, operation and maintenance of the Aquastar Control
- Unauthorized modification of the Aquastar Control
- Insufficient monitoring of components subject to wear and tear
- Inadequately performed repair of the Aquastar Control
- Damage of the Aquastar Control resulting from foreign matter or Force Majeure

Leak and function tests have to be carried out before commissioning. After the pressure test, all nuts and screws of the entire pipe system must be retightened in a depressurized state.

We recommend a maintenance service (testing of functionality and tightness) and careful visual inspection in regular maintenance intervals, whereas with high aggressive media, strong vibrations and significant variations of temperature, the intervals must be shortened. Seals must be considered as wear materials and must be lubricated and/or changed regularly. With unfiltered media we recommend the installation of line strainers.

Enduring damage due to neglect of the operation manual or due to damaging sealed parts lead to a lapse of the warranty. We do not take any liability for resulting damages thereof! Please read the operation manual carefully before starting operation.

4 Instructions for Safety at Work

- Each person, involved in the user's facility, in the installation, dismantling, putting into operation, operation or maintenance of the Aquastar Control must have read and understood the entire operation manual and, in particular, the chapter "Safety Instructions".
- The instruction and warning signs calling attention to dangers must be taken into account!



Dangerous voltage!
This is for your own safety

5 Safety Instructions

- This equipment has been built and examined according to safety precaution for electronic devices and has left the plant in a perfect safety-related condition
- To keep this status and to guarantee a safe operation, the user must observe the safety instructions, which are included in these instructions
- This installation work may only be undertaken by an authorized and licensed installer or electrical business
- This equipment is not intended for it by persons (including children) with reduced physical, sensory or mental abilities or for lack of experience and/or for lack of knowledge to be used it is, it by a person responsible for their security is supervised or received from it instructions, how the equipment is to be used. Children should be supervised, in order to guarantee that they do not play with the equipment.
- The electrical installations must be carried out according to the respective local and regional regulations (e.g. OEVE, VDE, ...) and possible official regulations
- The electrical connection must have a separating device built into the permanently installed electrical installation, which enables the disconnection of all electrical contacts with a contact space of min. 3 mm from the mains.
- Pay attention that the supply voltage is correctly protected and an earth-leakage circuit breaker ≤ 30 mA is installed.
- Only use the equipment in dry rooms, in which no combustible gasses and vapors are present.
- Do not put the equipment into operation immediately if it has been taken from a cold to a warm area. The thereby developing condensation water could destroy your equipment.
- If the equipment has visible damage, does not work anymore or has been stored under adverse conditions for longer periods, a safe operation can no longer be possible. In this case the equipment is to be secured against unintentional start-up and if necessary to be decommissioned.
- Live parts can be uncovered when opening the cover or removing parts. Before an alignment, maintenance, a repair or change of parts or devices, the equipment must be separated from all voltage supplies, if opening the equipment is necessary. If after that an alignment, maintenance or a repair on the opened equipment under voltage is inevitable, it may only be done by experienced, skilled staff, which has knowledge of the associated dangers and/or the relevant regulations.
- Capacitors in the equipment can still be charged, even if the equipment is separated from all voltage supplies.
- Assembly and/or disassembly of the valve only in a pressure-free status (i.e. empty piping beforehand)
- Valve flow and/or direction of flow must be considered.



**Each person involved in the operation and maintenance of the equipment must have read and understood the present operation manual!
It is for your own safety!**

6 Residual Risk

6.1 Hazard Generated by Current



Manipulation of the Aquastar Control by operating staff is strictly prohibited and may only be performed by duly authorized staff, qualified for electrical work. Compliance with the corresponding instruction and prohibition signs is required.

6.2 Hazard Generated by Human Error



The operating staff must be instructed in regard to the residual danger resulting from electricity and familiarized with correct operation. Efficiency of the safety training must be verified.

6.3 Hazard Generated by Current during Cleaning Work



Cleaning of the Aquastar Control may only be performed after disconnection from power supply (lever switch).

7 General

PRAHER Aquastars are significant technical products, which are manufactured with high accuracy to the most modern technical production methods. Entitled complaints will naturally be rectified as fast as possible if they occur. The equipment has a warranty after valid European law. The warranty begins with the purchase date.



ATTENTION! For relief of the sealing system the valve is shipped on intermediate position and is not sealed! Prior to operation, it has to be electrically set to position "Filter"!

8 Directions for Use

This is a control unit for a **Praher Plastics 6-way valve**.

With an Aquastar Control, a sand filter or the like is backwashed fully automatically by time and optionally by pressure or external triggering.



Never operate the Aquastar without a Praher V6 valve in order to avoid damage to the device

A filter pump connection is available which switches off when the valve is lifted and, depending on the settings in the system, switches on via the corresponding functions

There is an electrical connection option for a **Praher Plastics ball valve with E0510 actuator** to the duct and further relays are available which can be wired and configured as described in the instructions.

In addition, there are digital and analog inputs that can be used for control and regulation functions.

9 Assembly

Device installation – installation of the valve

Install the valve in the conduit according to the labeling and the sketch below. Use adapter unions. Threaded connections should be sealed only with Teflon strip. Although the device is functional in any position, it must not be installed with the actuator facing down. If the difference in level between system and tank exceeds 3 meters, stop valves. Non-return valves should be installed to prevent severe damage to the actuator and the valve due to excessive pressure and flow. As filter medium can be washed out during backwashing and rinsing, we recommend fitting the drain with a throttle. Otherwise a stuck valve disk can adversely affect the flawless functioning of the Aquastar. Polluted or grainy filtering media require the use of adequate pre filters.



Important! During a cycle (lifting and rotating), the filter pump must be shut off.

The Praher Plastics Aquastar Control is only approved for 6-way valves by Praher Plastics Austria GmbH. Malfunctions can occur with any other valve type as we are unable to guarantee that these valves match the dimensions of the Praher 6-way valves.

9.1 Function Diagram for Praher Plastics Austria V6 Valves

<p>① FILTER filter top</p> <p>pool → Pump → Valve (to filter) → Valve (from filter) → Pool</p>	<p>Filtration of medium (e.g. Water)</p> <p>Pool → Pump → Valve (to filter) → Valve (from filter) → Pool</p>	<p>② WASTE filter top</p> <p>Pool → Pump → Valve → Drain</p>	<p>Drainage of pool with pump</p> <p>Pool → Pump → Valve → Drain</p>
<p>③ CLOSED filter top</p> <p>No circulation. Do not operate pump</p> <p>Pool → Pump → Valve</p>	<p>No circulation. Do not operate pump</p> <p>Pool → Pump → Valve</p>	<p>④ BACKWASH filter top</p> <p>Pool → Pump → Valve (from filter) → Filter → Valve (to filter) → Waste</p>	<p>Cleaning up filter medium (e.g. Sand) in upstream (reversed flow in filter)</p> <p>Pool → Pump → Valve (from filter) → Filter → Valve (to filter) → Waste</p>
<p>⑤ RECIRCULATE filter top</p> <p>Pool → Pump → Valve → Pool</p>	<p>Recirculation of fluid without filter (Bypass filter)</p> <p>Pool → Pump → Valve → Pool</p>	<p>⑥ RINSE filter top</p> <p>Pool → Pump → Valve (to filter) → Filter → Valve (from filter) → Waste</p>	<p>Cleaning of filter medium (e.g. Sand) after backwash</p> <p>Pool → Pump → Valve (to filter) → Filter → Valve (from filter) → Waste</p>

6-way valve type: 1,5", 2" and 3"

Connections: Thread or stick (all connectors open)

Max. Operating pressure: ABS: 1,5", 2" → 3,5 bar
 ASA-GF: 1,5", 2" → 6 bar
 ASA-GF: 3" → 5 bar

Even when retrofitting, the Aquastar must not be built on a 3 "ABS valve. With 3 "an ASA-GF valve is to be used.

	Pump → from pump
	Top → to the filter
	Bottom → from filter
	Return → to the pool
	Waste → to the drain

10 Electric Connection

10.1 Connections on the Front of the Circuit Board

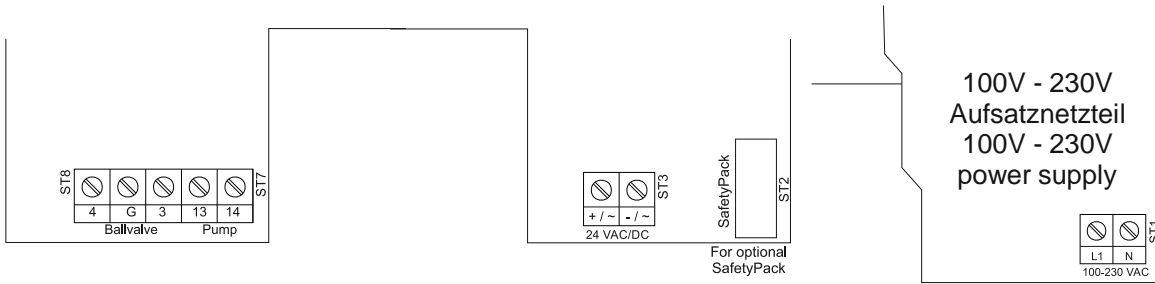

10.1.1 Connection of Supply Voltage- see type plate-

Aquastar Control 230 with additional power supply 100V – 230V:

100 – 240 VAC 50/60 Hz 20/30VA (170-300 DC)

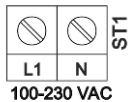

Aquastar Control 24:

12 – 24 VDC/AC 50/60 Hz 20/30VA

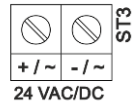

10.1.2 Connection for SafetyPack

The Aquastar SafetyPack is a battery pack that, in the event of an unsafe position of the Aquastar, if a power failure accrues, brings it into a safe position such as filters. Unsafe positions are backwash, rinse and if the valve is lifted up.

If the Aquastar Control is equipped with the Aquastar SafetyPack, the Aquastar SafetyPack is connected to the ST2 connector.

If you would like to equip the Aquastar Control with an Aquastar SafetyPack, you will find more information in the installation instructions in the retrofit set.

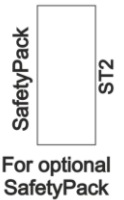

10.1.3 Connection for Pump

Terminals: (13, 14)

Potential free relay: U: 15-230VAC; I max. 8 A @ $\cos \varphi=1$

Use terminals [13→14] to control the pump (See 14.2 Filter Pump)

When valve is in position closed or unknown position, the relay pump never closes.

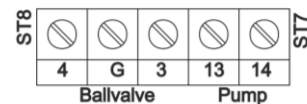

10.1.4 Connection for Ball Valve

Terminals: (4, G, 3)

Potential free relay: U: 15-230VAC; I max. 8 A @ $\cos \varphi=1$

If the actuator is switched off and on position 'filter' and 'circulate' the terminals [G→3] are connected. In position "Drain" and during backwash cycle the terminals [G→4] are connected.

10.1.5 Connection Diagram for Pump and Praher Ball Valve EO510

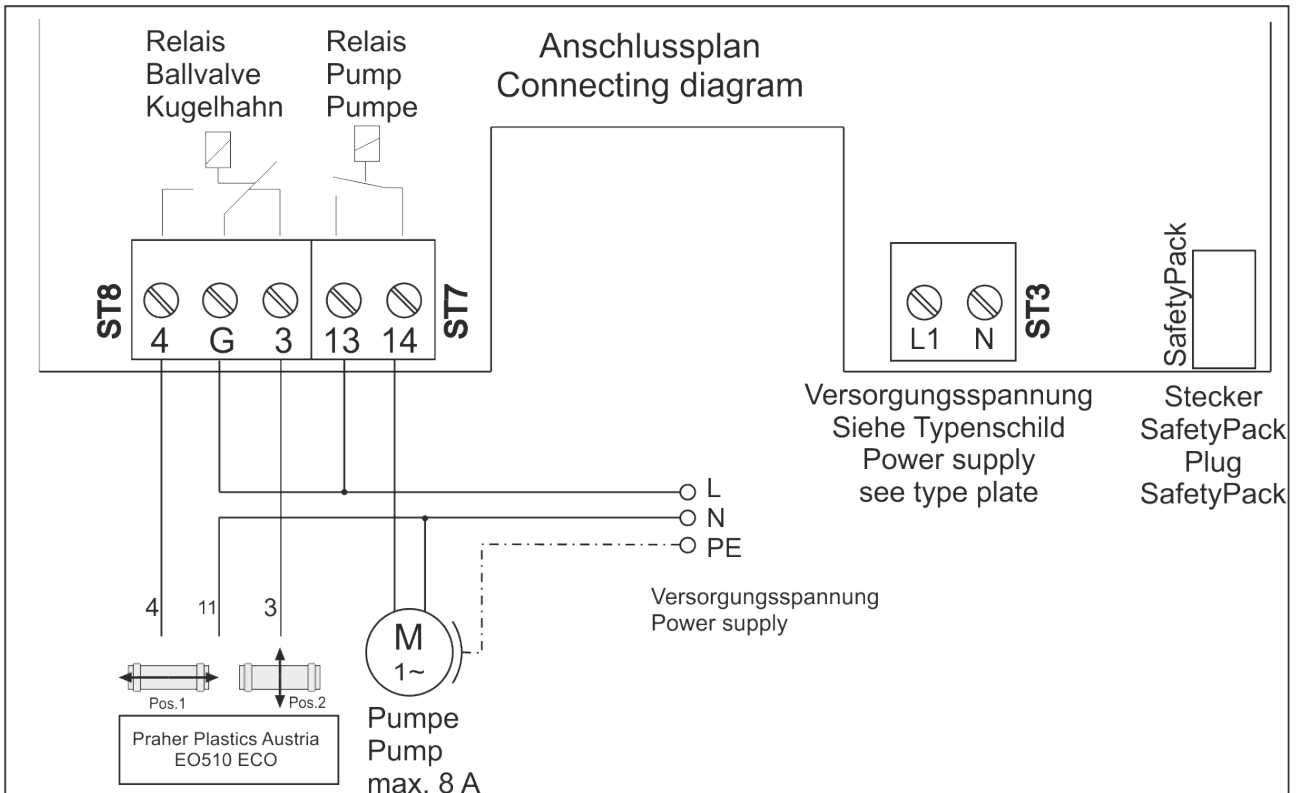
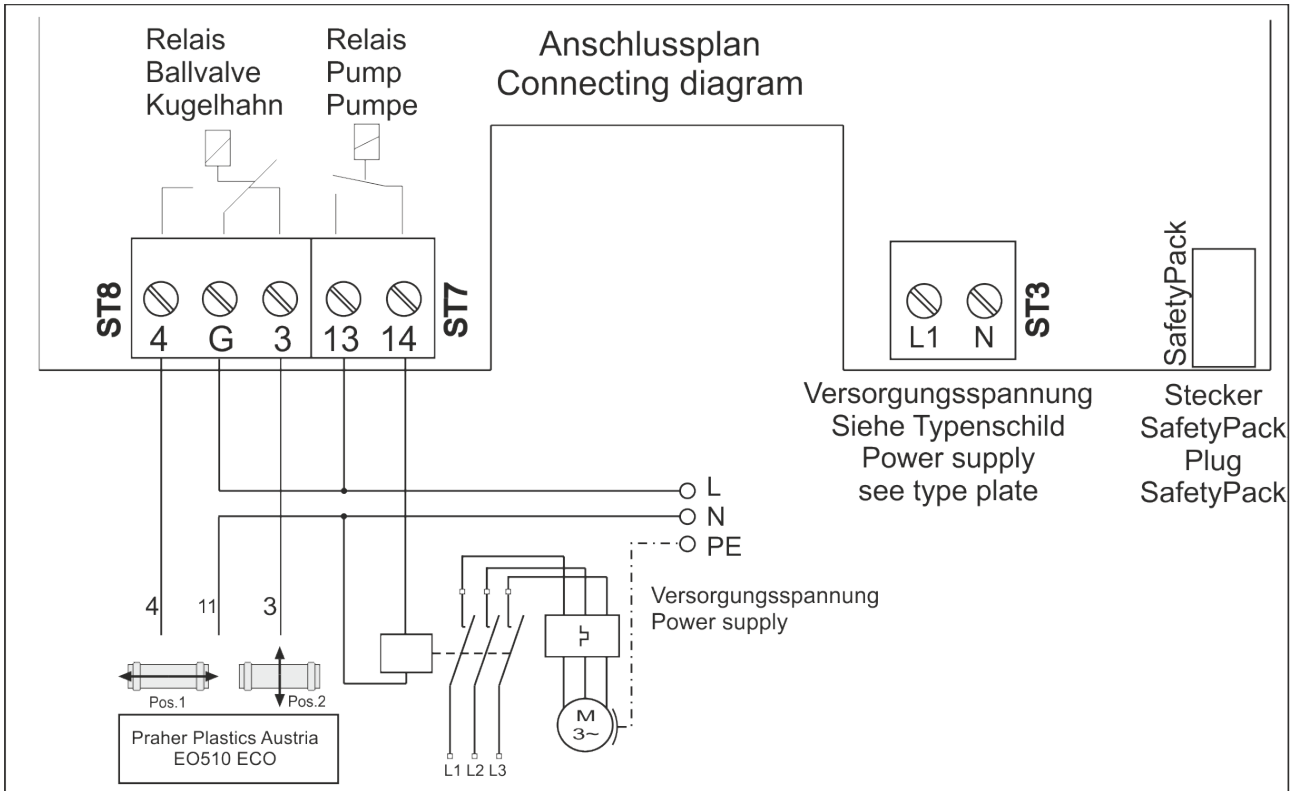

10.2 Connections on the Back of the Circuit Board

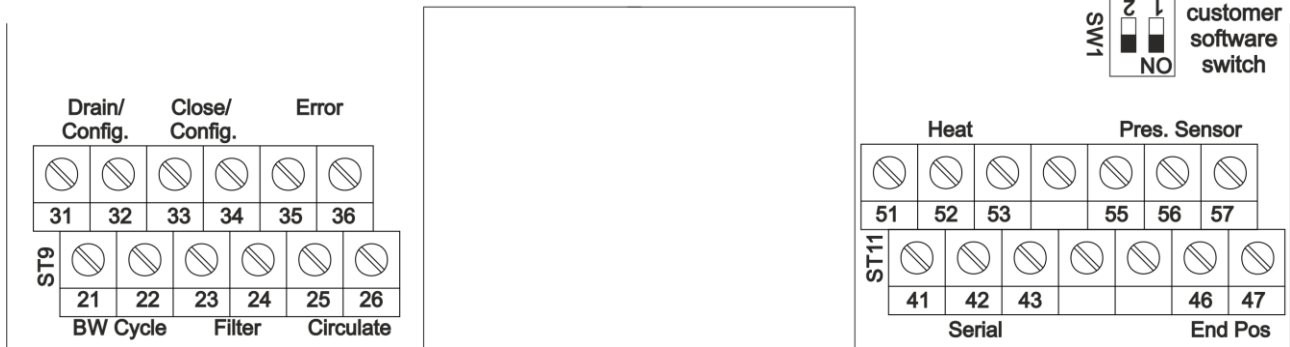

10.2.1 ST 11 Connections

A) Pressure Sensor 0 – 6 BAR:

Terminals: (55, 56, 57)

Connect only the Praher Plastics Austria pressure sensor to these contacts.

Device number of the pressure sensor set is 131450

GND : standard white wire; terminal connection 55

PS : standard green wire; terminal connection 56

+5V : standard brown wire; terminal connection 57



B) Heat control/solar control: (See 13.2 Heating Control)

Terminals: (51, 52, 53)

Potential free: I max. 4 A

When heating/solar is required, the terminals [51→52] are connected. Otherwise terminals [51↔53] are connected.

Note: After opening terminals [51→52], pump connection (Terminals [13→14]) stays connected at least for heat delay time to cooling down heating rod or heat exchanger. After time delay, the pump shuts off.

C) Position switch:

Terminals: (46, 47)

On these terminals the micro switch for positioning is connected. This must not be changed.

D) Serial relay: (Configurable)

Terminals: (41, 42, 43) (See 14.7.7.1 Relay Outputs)

)

Potential free relay: U: 15-230VAC; I max. 4 A @ cos φ=1

With the standard setting, this relay can be used to connect several Aquastar in series

If a backwash cycle is started, the terminals [41→42] are switched through for the set time.

Or a level control is possible in connection with this relay. If refilling is to be carried out, the terminal [41→42] is switched through when the pool is full [41→43] are closed.

10.2.2 ST9 connections

Potential free relay: U: 15-230VAC; I max. 4 A @ cos φ=1

To set the configurable relays. (14.7.7.1 Relay Outputs)

- A) Connection backwash cycle
During the whole cycle terminals [21→22] are connected
- B) Connection position filter (configurable)
On position filter the terminals [23→24] are connected or is configurable
- C) Connection position circulate (configurable)
On position CIRCULATE the terminals [25→26] are connected or is configurable
- D) Connection position drain(configurable)
On position DRAIN the terminals [31→32] are connected or is configurable
- E) Connection position closed(configurable)
On position CLOSED the terminals [33→34] are connected or is configurable
- F) Connection error signal
If an alarm occurs, the relay in the corresponding setting is driven [35→36]. See 14.5 Notifications

	Drain/ Config.		Close/ Config.		Error	
	31	32	33	34	35	36
ST9	21	22	23	24	25	26
	BW Cycle		Filter		Circulate	

10.2.3 Switch SW1

This switch is reserved for customer-specific software and has no function for normal operation of the Aquastar Control

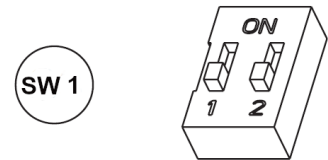

10.3 Connections at the Center of the Circuit Board

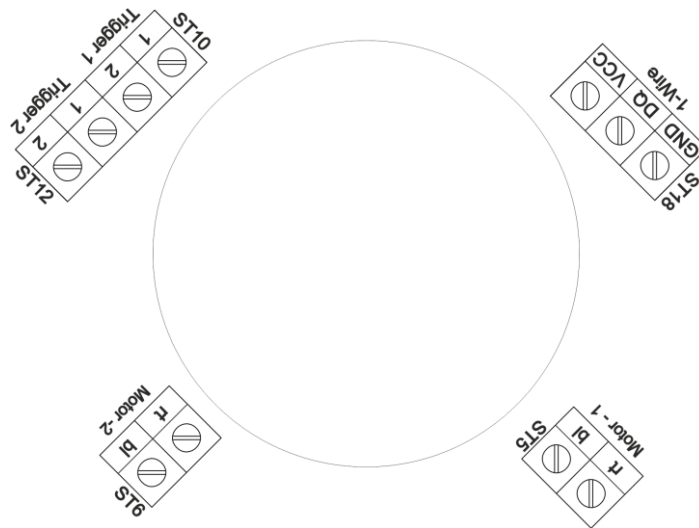

10.3.1 Temperature Sensor Connection

Temperature sensor connection is through ST18. Connect only DS18B20 sensors to this clamp (+VCC: green cable, DQ: white cable, GND: brown cable)

You can connect a maximum of three sensors in parallel to this terminal.

ST18	GND	DQ	VCC
	1-Wire		

10.3.2 External Triggers

- These are adjustable external triggers. Activating (ST10) or (ST12) the potential free contact for more than one second, the set user defined action will be triggered. See ☒

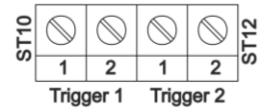

Digital Inputs



**Important! Connect these terminals only to potential free contacts!
Do not connect these clamps to voltage!**

10.3.3 Motor

The geared motors are connected to the terminals Motor - 1 and Motor - 2 at the factory. These connections must not be changed.

11 Battery

The device uses CR2032 Coin lithium battery to keep the RTC running. The battery is in a battery holder, attached to the control board. Battery life varies based on environment of the device. Symptom of battery failure is incorrect system date and time. If the battery is empty, the time and date are no longer correct after a power failure.



Battery specification: CR2032 3V lithium battery.

11.1 How to Change the Battery:

1. Disconnect the supply voltage.
2. Open the Aquastar lid.
3. Take out the old battery.
4. Insert the new battery so that the (+) side of battery faces the (+) side of battery holder.
 - a. The flat side of the battery is always positive.
 - b. Do not install a used battery.
5. Close the Aquastar lid and turn on the device.

11.2 Disposal Considerations:

1. Do not incinerate or dispose of lithium batteries in general waste collection. They may explode or rupture violently.
2. Collect batteries for disposal carefully to prevent short-circuiting, compacting, or destroying the battery case.
3. Review and comply with all relevant local, state, and country regulations dealing with the disposal of these materials.

Note: You are legally responsible for hazards created while your battery is being disposed

12 Display and Buttons

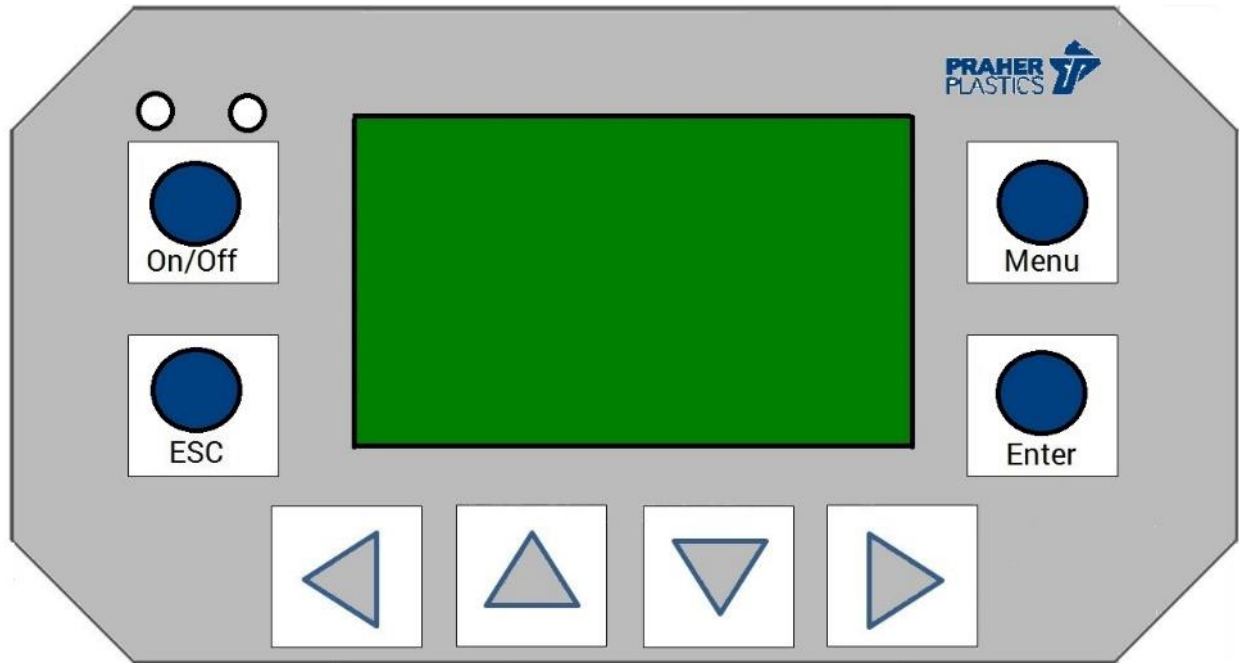

1. On/Off: Pressing this button switches the device on or off regardless of valve position. When the green LED is illuminated, i.e. the valve is not in a safe position, it will automatically go to position filter. The safe positions are: filter, close, circulate.
2. ESC: pressing this button closes menus and goes to splash screen, pressing more than two seconds sets the valve position to filter and resets previous positioning.
3. Menu: pressing this button opens main menu.
4. Enter: pressing this button activates selected menu object.
5. Arrow buttons(◀ ▶ ▲ ▼): change the selection

13 Splash Screen

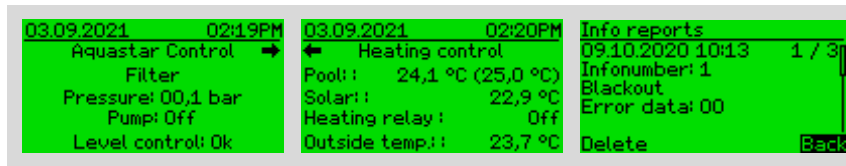

13.1 Standard

Standard splash screen is always available and shows the following information:

1. Date and time
2. Device's name, if temperature control has been activated right arrow will be displayed
3. Valve's current position
4. Measured pressure
5. Filter pump status
6. If level control is active and filling a status is shown

13.2 Heating Control

Heat control screen is available if heat control is activated. It shows the following information:

1. Date and time
2. Heating control
3. Pool temperature and Reference temperature in brackets
4. Solar temperature
5. Heat relay status
6. Outer temperature

13.3 Error/Information

1. Error type (Info / Error report)
2. Date and time of occurrence
3. Error number (see Troubleshooting Software)
4. Error in text form
5. Error data
6. Reset / Delete error
7. Back

14 Main Menu



The main menu opens through pressing **menu button**.

Using the **arrow keys** you can navigate through the menu. Selecting a menu item, inverts the icon and its function is displayed on top right.

To open desired menu select it and then press the **enter button**.

14.1 Backwash

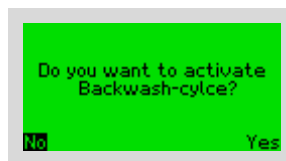

In this menu point, it is possible to activate a backwash cycle. It opens a confirmation message: To navigate to Yes press **◀** or **▶**. Pressing **enter button** will select the desired option. Yes will activate a backwash cycle, and accordingly an information will be displayed. Otherwise, main menu is opened.

14.2 Filter Pump



This menu point is for filter pump related settings. Available menu items depend on selected filter pump status.

14.2.1 Modes

14.2.1.1 Manual Mode

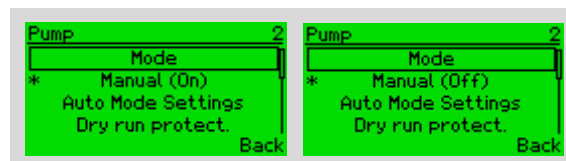

Pump switches on / off permanently (in position).

14.2.1.2 Resume to Auto Mode

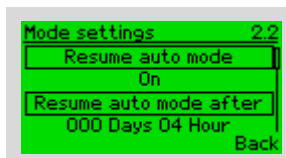

If filter pump status has been modified as manual (On/off), this menu item will be active. It is possible to switch pump to auto mode after a given time. Standard value for this menu point is 4 Hours, however it is possible to change the value as desired or even disable the function.

14.2.1.3 Automatic Mode

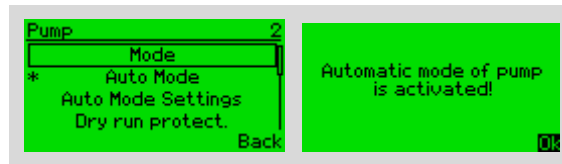

Filter pump switches on/off automatically according to schedule.

14.2.2 Auto Mode Settings

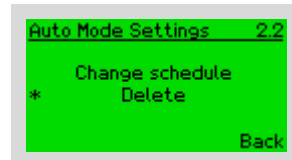

14.2.2.1 Change Schedule

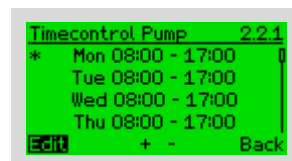

Selecting “change schedule” displays the time plan and it is possible to add, delete or modify entries.

By pressing ◀ or ▶ navigate between Back / remove (-) / add (+) or edit.

Navigation in plans is done by pressing ▲ or ▼.

After selecting a plan, by pressing ◀ or ▶ it is possible to navigate in the current plan’s times.

On/off time can be changed using ▲ or ▼. Selecting (x) at the end of the line and press **enter button** cancels the edit.

Additionally to days, an entry can be set to “daily”, so that it is configured for the whole week.

Note: Selecting “daily” generates a plan entry for each day. If there is an overlap with an existing entry, the overlapping entry will not be generated.

Note: If an input is invalid (there is already a plan for given day and time or it has overlaps with other plans), either delete the old plan or modify new plan to avoid overlaps.

14.2.2.2 Delete Entire Plan

All entries of the pump plans are deleted.

14.2.3 Dry Run Protection

The dry run protection prevents the pump from being damaged by a possible drop in the water level. The pressure sensor is used to determine whether there is a dry run.

Note: If you have not connected a pressure sensor, you cannot use this function.

14.2.3.1 Mode

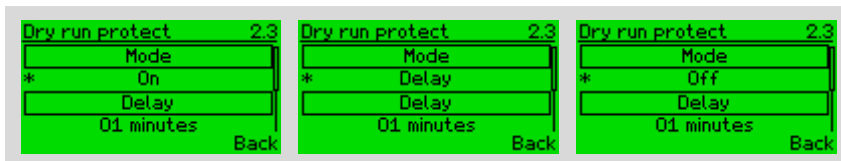

On	Off	Delay
If a dry run occurs, the pump will be deactivated.	The pump will not stop if it runs dry.	The dry run protection is paused for the time described below.

14.2.3.2 Delay Duration

The delay duration indicates how long the dry run protection will be suspended in order to carry out maintenance or commissioning.

14.3 Positioning



In this menu, it is possible to set the valve position manually. Available manual positions and processes are:

- Filter
- Drain
- Circulate
- Closed
- Winter mode
- Backwash cycle

Circulate



Closed



Filter



Drain

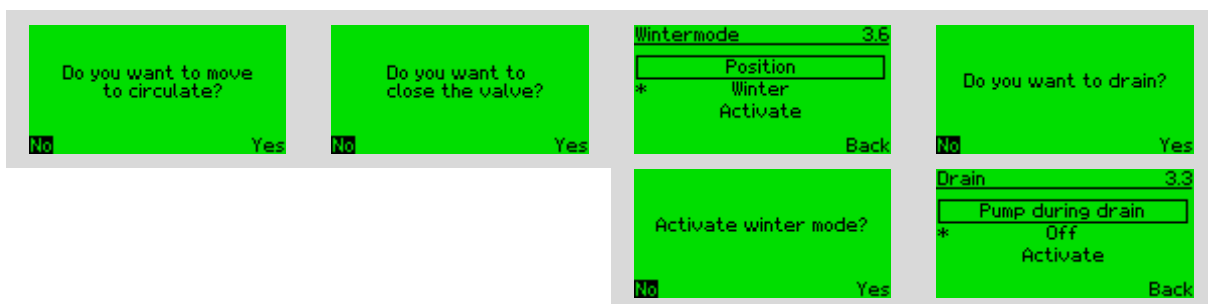

A confirmation page is opened by selecting the corresponding menu item. If "Yes" is selected, the valve will move to the desired position and information will be displayed accordingly. Otherwise, the positioning menu is displayed.

14.3.1 Winter Mode

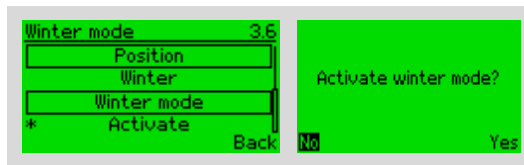

The valve position in winter mode can be closed, circulating, filtering and the lifted state. During the winter, the control of the pump and relay is deactivated.

When the winter mode is active, you will be asked for each positioning whether the Aquastar should be set back to normal or not.

14.3.2 Backwash



All the possible settings for backwash cycle are in this menu.

Available menu options are:

- Activate: Triggers a backwash cycle
- Time control backwash: Backwash mode and inputs
- Settings: Backwash cycle duration's settings

14.3.2.1 Activate

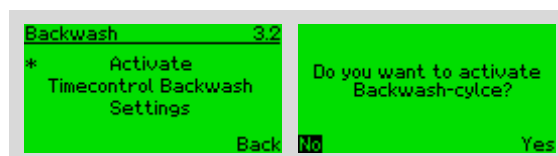

With selecting this menu item, a conformation page will open: to confirm select "Yes".

14.3.2.2 Time Control Backwash:

In this menu item, it is possible to select a desired backwash mode and edit related entries.

Available modes are:

Manual

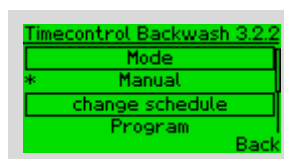

With selecting this mode, backwash cycle starts only manually. (To activate backwash manually see (14.1).

It is also possible to view or edit the backwash schedule for the automatic mode. However, the plan will not run if the mode is set to manual.

Every xx Days

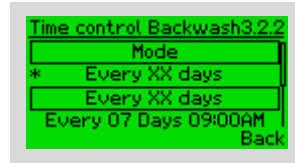

With selecting this mode, backwash cycle will be executed automatically as a desired interval day at a given time. In this example backwash will be performed every 7th day at 9:00 AM.

Automatic

In this mode backwash will take place as configured in the plan.

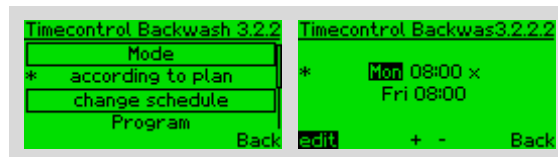

By pressing ◀ or ▶ the menu will navigate between Back/remove (-)/add (+) or edit.

Navigation between entries is done by pressing ▲ or ▼.

After choosing a plan, by pressing ◀ or ▶ it is possible to navigate in the current plan's date, start time or x. In addition, with ▲ or ▼ it is possible to change the selected value. Selecting (x) at the end of the line and pressing the **enter button** cancels the edit.

You can set an entry for a specific day or for the whole week.

Note: If you select daily, entries will be generated for the individual days. If there is an overlap, no entry is created for the respective day.

Note: If an input is invalid (there is already a plan for given day and time or it has overlaps with other plans), either delete the old plan or modify new plan. There should be at least one hour between each backwash cycle.

14.3.2.3 Further Settings

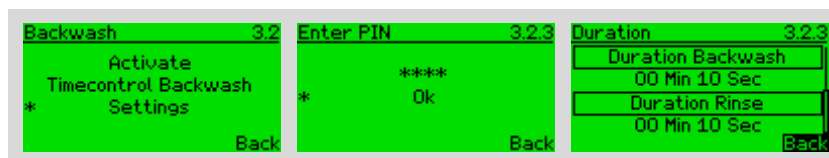

In this menu option it is possible to change adjustable times for backwash cycle, this menu item is PIN protected to avoid unwanted changes. Enter the PIN then press the **enter button** on ok.

Available settings for backwash cycle are backwash duration and rinse duration.

14.3.3 Back



With selecting "back", the menu level will go back to the main menu.

14.4 Statistics

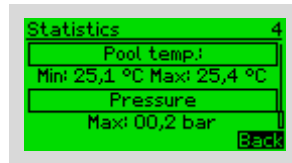

In this menu various statistics can be found, such as measured values summary and operating states.

14.5 Notifications

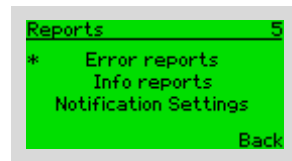

This menu contains error reports, info reports and possible settings for notifications.

14.5.1 Error reports

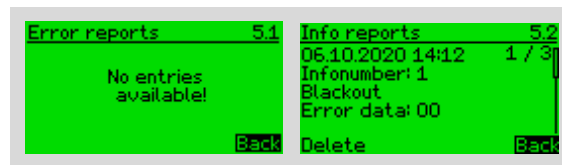

It has the following information in each page:

1. Error type (Info/Error report)
2. Date and time of occurrence
3. Error number (see Troubleshooting Software)
4. Error in text form
5. Error data
6. Reset/Delete error
7. Back

14.5.2 Notification Settings

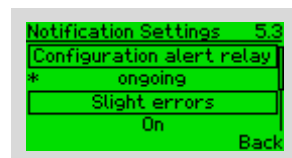

This is the same menu as described in 14.7.5 Notification Settings (Page 26).

14.6 Information

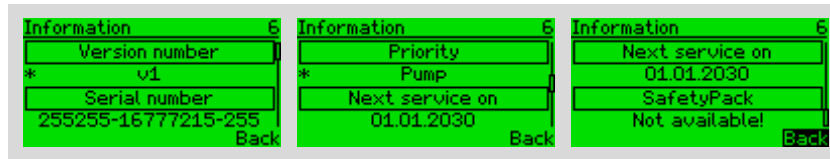

This menu displays various information about Aquastar control such as:

- Software version
- Serial number
- Next service date
- Priority
- Safety pack availability.

14.7 Settings



In this menu you find all system related settings.

14.7.1 Language

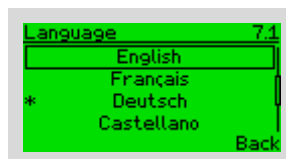

This menu item is to change the language of the display.

Note: If the language changed to English, the time format will automatically change to HH:MM and date format will be DD.MM.YYYY.

14.7.2 Date/Clock

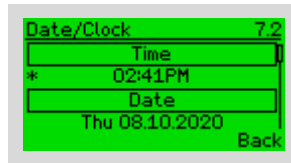

To set the current time select menu item time by pressing the **enter button** using **▲** or **▼**. The value now changes and using **◀** or **▶** it is possible to navigate between hours and minutes. Selected digits will be inverted. Enter the current time and press enter to update the system time. The same applies for the system date.

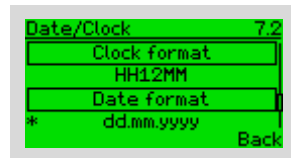

To change the time format under clock format press the **Enter button**, by **▲** or **▼** choose the time format you want and by pressing the **Enter button** again the time format will be updated. Available time formats are HH12:MM and HH24:MM

Date format configuration works in a similar way. Available formats are: mm.dd.yyyy, dd.mm.yyyy und yyyy.mm.dd

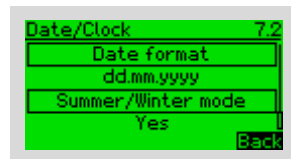

Finally, it is possible to set whether an automatic adjustment to summer or wintertime should take place.

14.7.3 Units

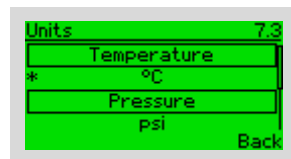

It is possible to change the temperature and pressure units. Available temperature units are degrees Celsius or Fahrenheit. Available pressure units are Pascal, psi or Kilopascal.

14.7.4 Sleep Mode

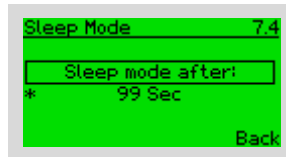

This menu item is to change the display time out. Minimal value is 10 seconds and maximum is 99 seconds.

Please note: All other functions will remain active.

14.7.5 Notification Settings

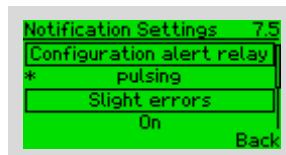

This menu item is to define error relay behavior in case of an error. Available settings are pulsing or continuous. Slight errors can be disabled.

14.7.6 Heating Control



This menu it is possible to activate/deactivate the temperature control if a temperature sensor has been connected and assigned its function (see 14.7.7.3)

To activate/deactivate temperature control press [Enter button](#) on heating option.

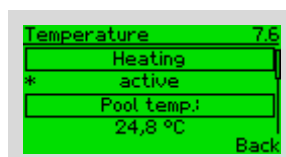

If a sensor has not been defined, the following message will appear. Information to define a sensor as pool sensor is in 14.7.7.3 Analog Inputs



After activation, the pool temperature will be displayed.

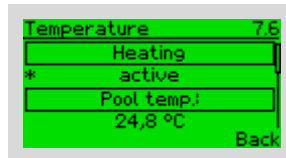

To set/change the reference value choose Reference value and press the **Enter button**, by pressing ▲ or ▼ reference value changes and press the **Enter button** in the desired value.

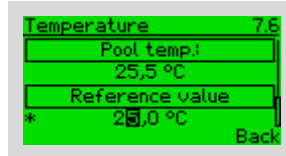

There is an option to get a warning if the pool temperature goes out of a defined range. Min and Max values can be set individually and can also be disabled separately.

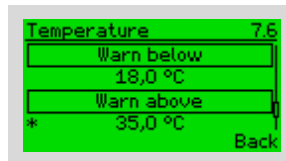

If a heat pump is used for heating it might have a low level affect at cold temperatures, therefore it can be switched off automatically if the outside temperature is below a certain level.

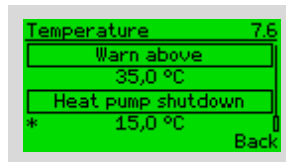

14.7.7 Advanced Settings



This menu is to change sensitive values and is PIN protected. Standard value for the PIN is 0000. After pressing **Enter button** on this menu device will ask to enter the 4-digit PIN. Using ◀ or ▶ it is possible to navigate on digit place and using the up and down button to set the value of the digit. After entering the PIN press the **Enter button**.

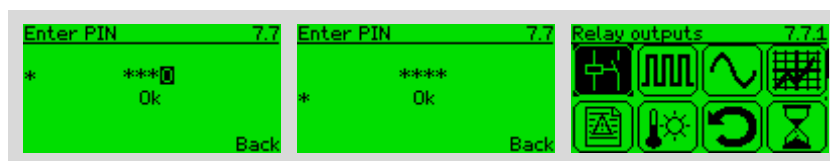

14.7.7.1 Relay Outputs

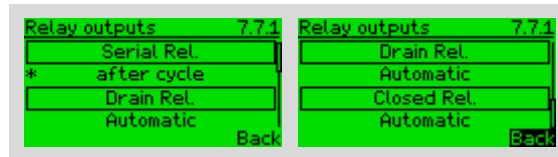

In this menu, some relays (serial relay, as well as the relays for draining, closed, filtering and circulating) can be provided with special functions. 10.2.1 ST 11 Connections)

Possible function for serial relays are: (Connection see

- **During the cycle:** Relay closes (Terminals [41→42] switched through) for 1-sec when backwash starts, otherwise Terminals [43→42] are switched through
- **After the cycle:** The relay is closed for one second (terminals [41→42] switched through) when the backwash cycle has ended. Otherwise terminals [43→42] switched through
- **Program:** The relay is controlled according to a weekly schedule.
- **Level control:** see 14.7.7.4 Level Control

Possible functions for the other relays are:

- **Automatic:** The relay closes according to valve current position
- **Program:** The relay is on a weekly schedule controlled.
- **Off:** The relay stay open all the time

14.7.7.2 Digital Inputs

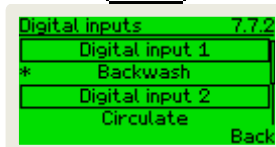

In this menu, it is possible to define a special position for valve, when the input is activate. Possible positions: filter, closed, circulate, winter or backwash cycle. Furthermore, there is a stop function for the pump.

If an input that is configured with a position is active for longer than 5 seconds filtering is started.

To start the positioning, the input must be actuated for 1 second.

If the level monitoring is activated, the associated input cannot be used.

14.7.7.3 Analog Inputs

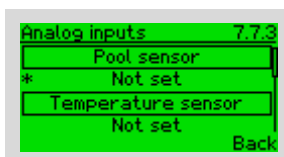

In this menu, it is possible to add temperature sensor and its function. Possible functions are pool temperature, outer temperature and solar temperature. During device startup device automatically searches for all suitable sensors and saves all connected sensors.

Please note: compatible temperature sensors are 1-wire sensors DS18B20.

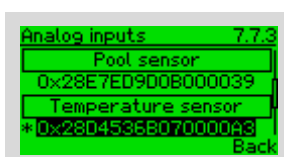

To define a pool sensor press the **Enter** button in this menu point and by pressing **▲** or **▼** all available sensors addresses will be displayed.

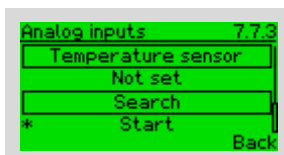

If the desired sensor is not on the list, please perform a new search.

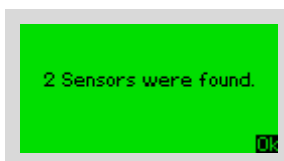

Note: to activate temperature control you need to activate it in Heating Control, this menu is just to define sensors function.

Calibration of the Pressure Sensor

To increase the accuracy of the pressure sensor, you can calibrate it. To do this, you must ensure that the pump is switched off and then press the Enter key in this menu on pressure calibration.

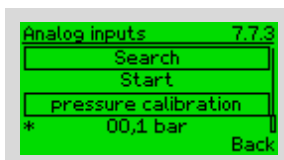

14.7.7.4 Level Control

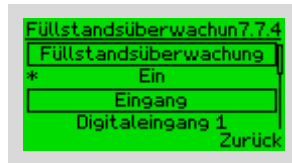

To activate level control there must be a pool level sensor connected to digital input, and the serial relay (Terminals: (41, 42, 43)) to control the inflow. In order to prevent the pool from running out in the event of leaks, filling is stopped after a configurable time and an error is displayed. If the level is too low, the level switch has to close continuously for one minute.
 Level Sensor See 20 Aquastar Control Accessories (page 38)

14.7.7.5 Notifications

See 14.5 Notifications (page 23)

14.7.7.6 Heating Control

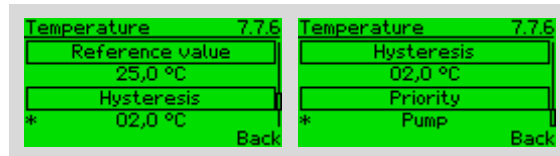

For the basics of this menu see 14.7.6 Heating Control (Page 26).

Additionally the hysteresis and the priority can be set here.

With "Pump" priority, the heating will only be activated if the pump is switched on according to the time control and the valve is either in the filtering or circulating position.

With priority "heating", the pump will be switched on when there is a heating request if it is operated in automatic mode and the valve is in either the filtering or circulating position.

14.7.7.7 Reset

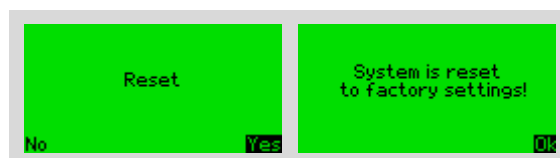

By using this function, all configurations will be deleted and the device returns to the factory settings.

14.7.7.8 Duration

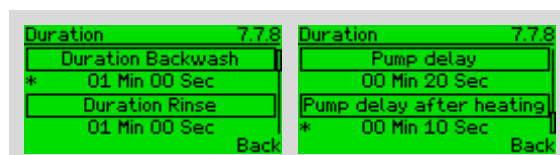

The individual times for the backwash cycle and the pump and heating can be set here.

14.7.7.9 Pressure Triggering a Backwash Cycle

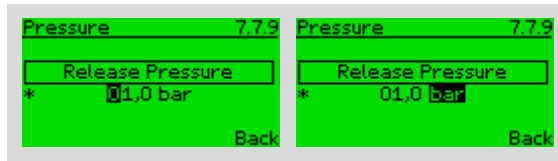

The pressure, at which a backwash cycle triggers, can be set here.

14.7.7.10 Statistics

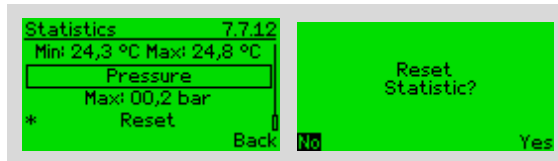

See 14.4 Statistics (page 23).

It is possible to reset the statistics here.

14.7.7.11 Change PIN

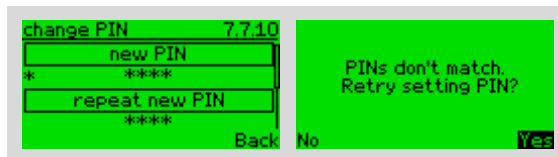

In this menu, the user can change the PIN for the advanced menu.

If you have forgotten the pin, you can only access this menu by pressing **ESC** for 10 seconds.

14.7.7.12 Information



See 14.6 Information (Page 24).

If the menu is opened in the admin mode as it is here, it is also possible to change the next service date.

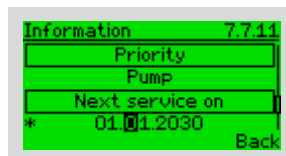

To change next service date, press **Enter** on next service and use **◀** or **▶** to navigate through date and by pressing **▲** or **▼** to set desired date. Pressing **Enter** again sets the next service date.

14.7.7.13 Pump Detection

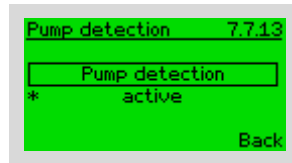

Here you can set, if no pump is connected, a possible backwash.

14.7.7.14 Dry Run Protection



For the basics of this menu see **Fehler! Verweisquelle konnte nicht gefunden werden.** Dry Run Protection (Page 19)

Here it is possible to set the minimum acceptable pressure to run the pump. Standard value is set to be 0.2 bar. However, it is adjustable between 0.1-0.5 bars.

14.7.7.15 Back



Selecting this item returns to the settings menu.

14.7.8 Back



Selecting this item returns to the main menu.

16 Explosion Drawing of Aquastar Control

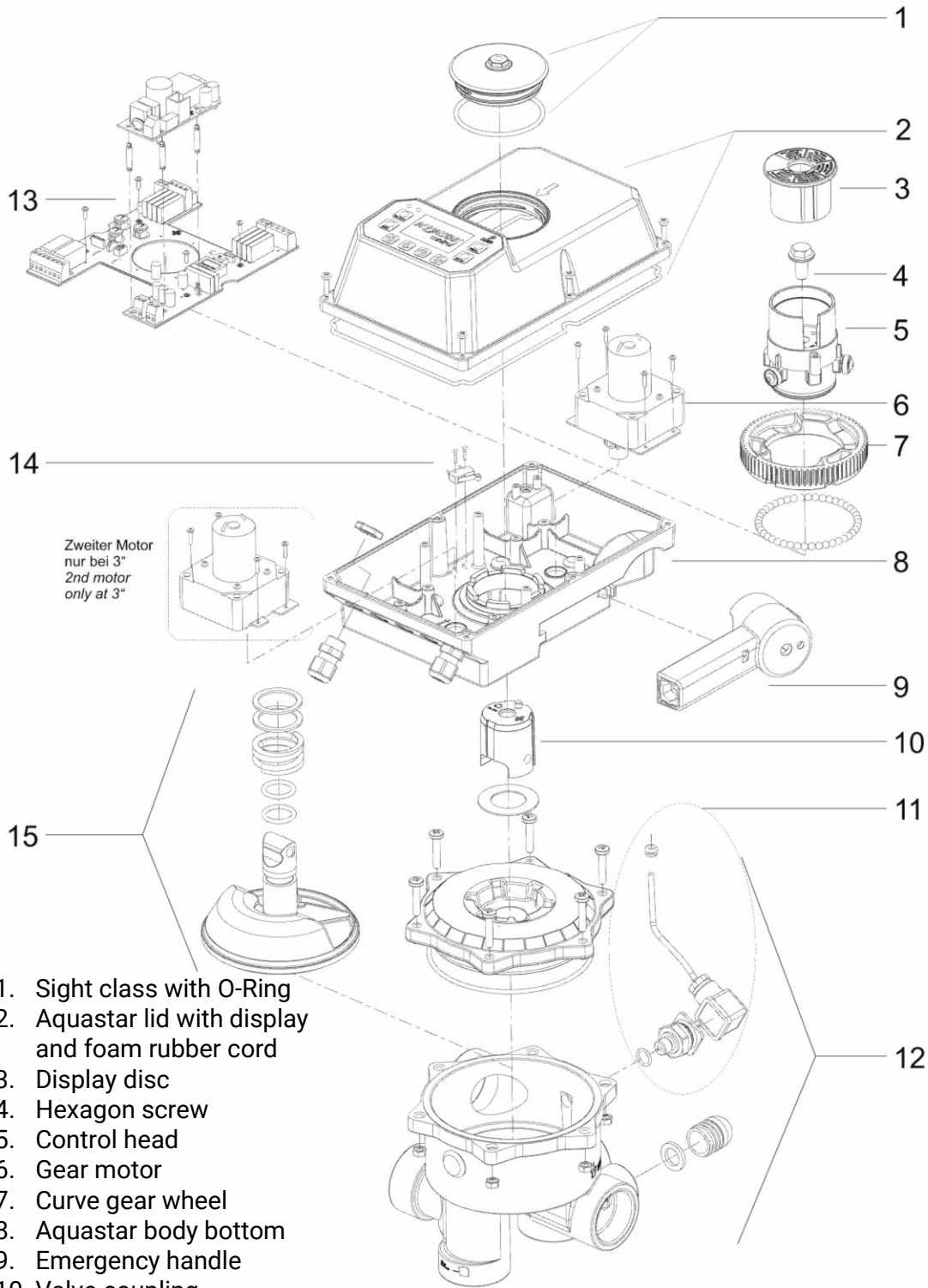

1. Sight class with O-Ring
2. Aquastar lid with display and foam rubber cord
3. Display disc
4. Hexagon screw
5. Control head
6. Gear motor
7. Curve gear wheel
8. Aquastar body bottom
9. Emergency handle
10. Valve coupling
11. Pressure sensor with cable and plug
12. V6ND valve 1 ½", 2"
13. Control board
14. Pump end switch
15. Valve plate with O-Rings and spring

17 Technical Data

Voltage:	24 V AC/DC 100-240V AC (170 – 300V DC)
Protection:	IP 65
Frequency:	50/60 Hz
Nominal current:	0,7 / 1A rms at 24V AC 0,5 / 0,7A at 24V DC 85 / 130mA rms at 230V AC
Max. power:	20W at 1,5"-2" / 30W at 3"
Relays pump:	8A at $\cos \varphi=1$
Relays ball valve:	8A at $\cos \varphi=1$
Small signal relays:	3A at $\cos \varphi=1$
Environmental conditions:	-20°C - 50°C, 0-95%RH not condensing
Max static pressure:	0,3 Bar
Max Water column	3m

18 Emergency Handle

In case of power loss or control problems:

1. Prior to using the emergency handle disconnect the Aquastar from the power supply.
2. Lower the system pressure (switch off pump, close ball valves, mind possible water columns)
3. Use the emergency handle according the capture 19 Fitting and Dismantling Aquastar Control

Emergency handle
Item No. 101862

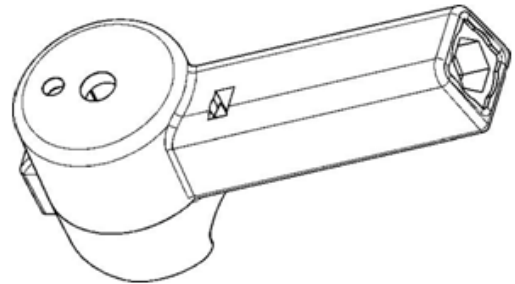

Attention

Lower the system pressure prior to using the emergency handle

**The emergency handle is not designed to replace the electric drive.
In order to secure proper function of the emergency handle it should
not be used permanently!**

19 Fitting and Dismantling Aquastar Control

19.1 Dismantling the Aquastar Control

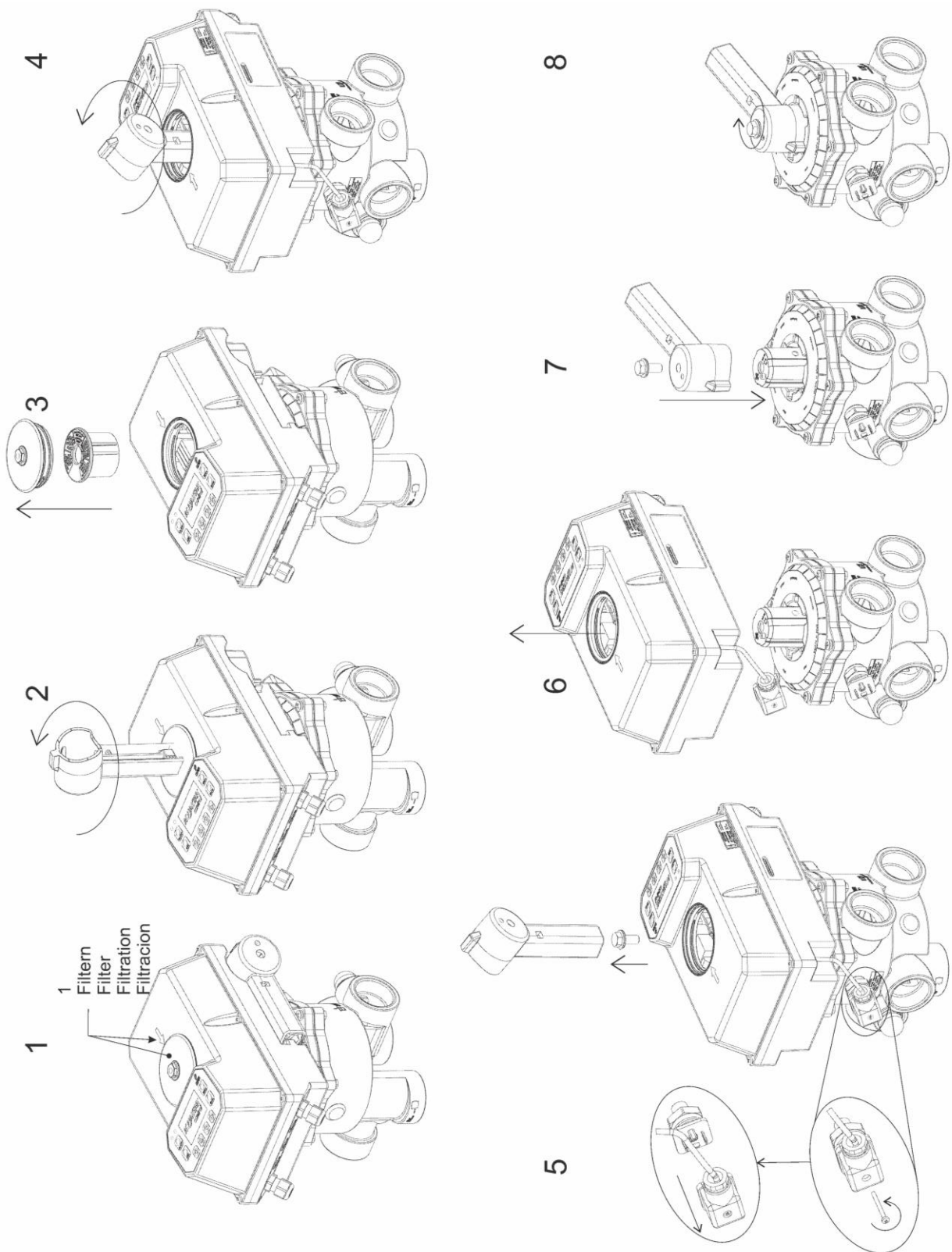

19.2 Fitting the Aquastar Control

Attention: During installation screw tight the center screw with a minimum torque of 10 Nm (pic. 6) to secure the functionality and screw the sight glass hand-tight (about 4Nm – 8Nm) in the lid (pic. 8) in order to secure tightness of the Aquastar Control!

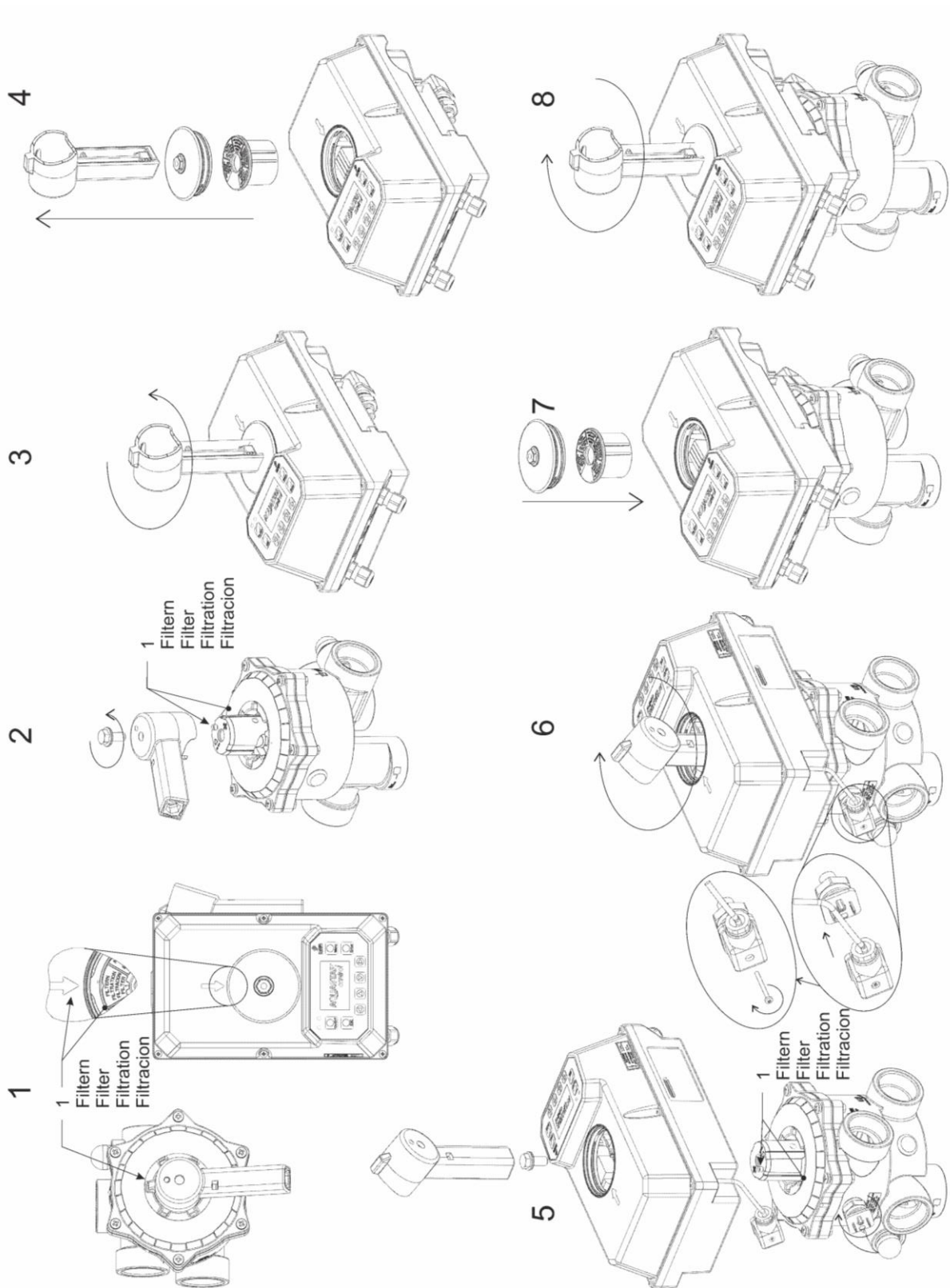

20 Aquastar Control Accessories

OCEAN-adapter unions male thread – solvent socket

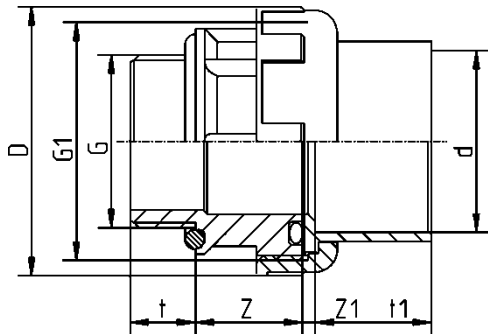

d - D	T	T1	Z	Z1	D	E1
50-1,5" BSP	18	31,5	30	3	74	2 1/4"
48,4-1,5" NPT	18	31,5	30	3	74	2 1/4"
50-2" BSP	23,5	31,5	36	3	92	2 3/4"
63-2" BSP	23,5	38,5	36	3	92	2 3/4"
60,3-2" NPT	23,5	38,5	36	3	92	2 3/4"

Sensos

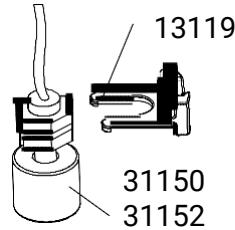

Article Number	Description
131195	Spare part kit for Niveau switch Skimmer Ocean DeLuxe
31150	MINISCHWIMMERSCHALTER 5m connection cable
31152	MINISCHWIMMERSCHALTER 15m connection cable
131450A	Spare part kit for Aquastar Easyll and Control - pressure sensor
131514	Spare part kit for Aquastar Control - temperature sensor

Line strainer S4

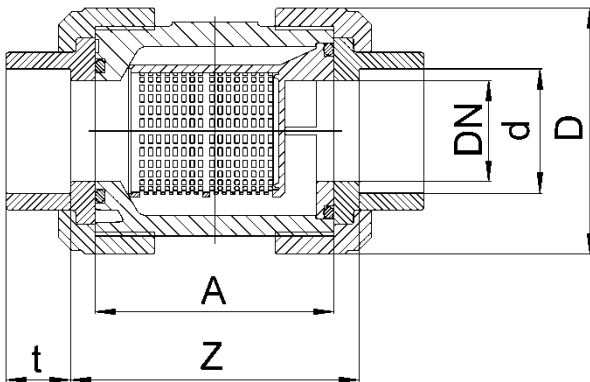

d	DN	A	Z	t	D	PN
50	40	95	104	31,5	101	16
63	50	109	121	38,5	124,5	16

Check valve S6

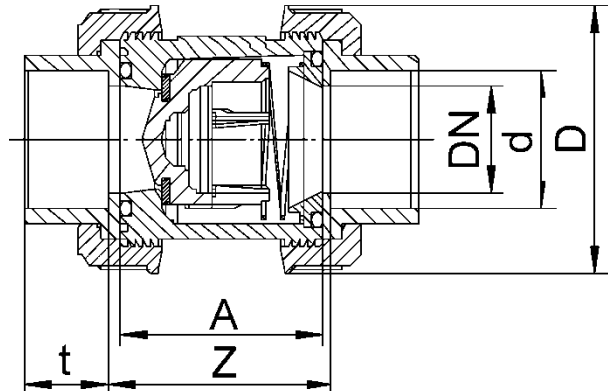

D	DN	A	Z	t	D	PN
50	40	77	87	31,5	101,5	16
63	50	87	99	38,5	115,3	16

PVC ball valve DN32 – DN50 S6 E0510 ECO 230V

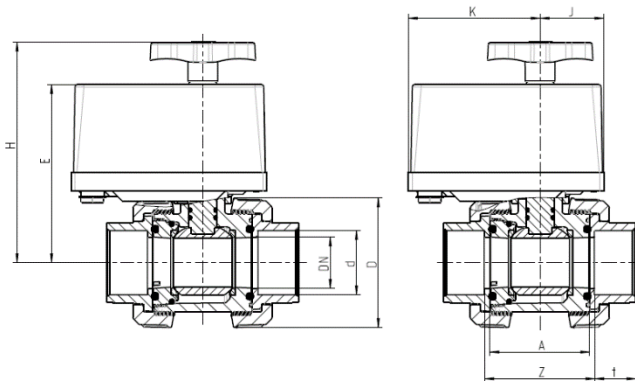

PVC	S6	S6	S6
DN	32	40	50
d	40	50	63
A	77	77	87
D	101,5	101,5	115,3
t	26,5	31,5	38,5
Z	87	87	99
PN	3	3	3
E	138,5	138,5	143,5
H	159	159	164
M	77	77	77
J	49,5	49,5	49,5
K	102,5	102,5	102,5

21 Troubleshooting

21.1 Troubleshooting Software

Number	Error	Cause	Action	Reset	Possible reasons
1	Power failure	The power supply has been interrupted	If the Aquastar is at an unsafe position, a safe one will be approached and it signals the power failure.	Connect power The pos relay then picks up again and the PLC must set the input again. Set input only when pos relay is switched on.	<ul style="list-style-type: none"> Power loss Cable break
3	Overcurrent error	The permitted motor current has been exceeded.	The motor stops. After one second, the Aquastar retries to reach position.	No need to reset. If current is below current-limit in the next attempt, normal operation continues.	<ul style="list-style-type: none"> Aquastar is not tightened enough to the valve Pump has not switched off Valve is not clean
4	Overcurrent error state	The permitted motor current has been exceeded three times in this position cycle	Aquastar is set to error state: No possible actions until error is reset	Error must be reset	<ul style="list-style-type: none"> Aquastar is not tightened enough to the valve Cable break Motor failure Valve is broken Pump has not switched off Water column >3m One motor is incorrectly connected (rt to red und bl to blue cable)
5	One hall error state	One Hall-Sensor has not responded.	Aquastar is set to error state: No possible actions until error is reset	Error must be reset	<ul style="list-style-type: none"> Defective Electronics
6	Hall error state	Motor has been turned on and within 2 minutes, neither a Hall sensor nor an end position switch event was recorded.	Aquastar is set to error state: No possible actions until error is reset	Error must be reset	<ul style="list-style-type: none"> Defective Electronics Insufficient power supply Motor failure Cable break Motor is not connected
7	End position switch not connected error state	End position switch does not trigger	Aquastar is set to error state: No possible actions until error is reset	Error must be reset	<ul style="list-style-type: none"> End position switch is not connected End position switch has bent incorrectly
8	Too many overpressure releases	The pressure backwash has been triggered 3 times in one day.			<ul style="list-style-type: none"> Wrong limit
9	Pressure error	Pressure does not sink below 0.5 bar after switching pump off	Aquastar waits for the pressure to drop and only starts moving when the pressure is below 0.5 bar		<ul style="list-style-type: none"> Pump has not switched off Lang pipe Pressure-increasing elements in the system

10	Temperature sensor separated	Defined temperatures Sensor does not communicate with μ c			<ul style="list-style-type: none"> • Cable break • Sensor is disconnected • 1_Wire Interface faulty
11	Pool temperature sensor not defined	Pool sensor is not defined or is incorrectly defined.			
12	Incompatible 1-wire Sensor	A 1-wire sensor with an unsupported family code was connected.			
13	Refilled too long	The pool is filled longer than defined time	Level monitoring is deactivated and filling is ended	Level monitoring must be reactivated	<ul style="list-style-type: none"> • Cable break • Sensor faulty • A leak in pool or pipes
14	Pump not connected	The pump waits too long when starting a BW.	Positioning is canceled (valve goes to filter position)		<ul style="list-style-type: none"> • Cable break • Pump-connection is faulty
15	Aquastar overheated	The temperature on the print has exceeded the maximum value.	Device switches itself off	Aquastar must be started again.	
16	Dry run protection active Error status	The pump pressure is too low	The Aquastar goes into error status: No actions are possible until reset		<ul style="list-style-type: none"> • No / not enough water in the pump
17	Temperature alarm	The water temperature is outside the valid range.	This is just a notification that something may be wrong with the heater.		<ul style="list-style-type: none"> • Heating out of order • Heater does not respond to control

Note: Error state means that the error needs to be resolved and then reset in order to use the device again.

21.2 Troubleshooting Hardware

- **The drive continually triggers the backwash cycle**
 - The system contains pressure boosting components (e.g., Solar absorbers)
 - Set the pressure sensor so that the Aquastar does not trip at this increased pressure
 - The pressure sensor was retrofitted on a device that has a blue pressure sensor switch below the PCB
 - Use the translation list enclosed with the pressure switch set, and set S3 or S4 accordingly
- **The pump fails to switch on or off**
 - See 14.2 Pump Settings
 - Relay burnt out
 - The maximum pump current of 8A was exceeded
 - The pump is not properly connected
 - The pump must always be looped via contacts 13-14
- **The disk is not lifting freely, or the drive is not running smoothly, or flow noises can be heard**
 - The pump does not switch off on lifting the valve disk
 - The pump must always be looped via contacts 13-14
 - The drop from the water surface to the valve is too great
 - Make sure that the total water column does not exceed 3m.
 - The V6 valve is soiled or clogged by foreign matter
 - Clean the valve and use a pre-filter
- **The date and time are no longer correct**
 - The clock's battery is almost empty or dead
 - Change clock battery (see 11 Battery)

Made in Austria/Europe.

© Praher Plastics Austria GmbH
Zertifiziert nach / certified acc. to
EN ISO 9001:2015
PM LD 7.1-002B DE_EN

Diese Druckschrift enthält keine Gewährleistungszusagen, sondern will lediglich eine erste Information vermitteln. Das Programm wird ständig erweitert, daher entsprechen die Ausführungen und Typen dem Stand bei Drucklegung. Technische Änderungen vorbehalten!

This publication includes no warranty, but will merely provide initial information. Due to continuous expanding product range, the standards and types correspond to the date of printing. Technical modifications reserved!

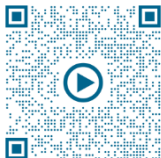

Videoanleitungen:

Montageanleitungen/Assembly instruction:
<https://www.youtube.com/playlist?list=PL2jaAb-ZBnqISKbU0XC5zUYsmlqnIE08LR>



POWER.
VALVE-CONTROLLED

Praher Plastics Austria GmbH
Poneggstraße 5 . 4311 Schwertberg . Österreich
T +43 (0)7262 / 61178-0 . F +43 (0)7262 / 61203
sales@praherplastics.com . www.praher-plastics.com